

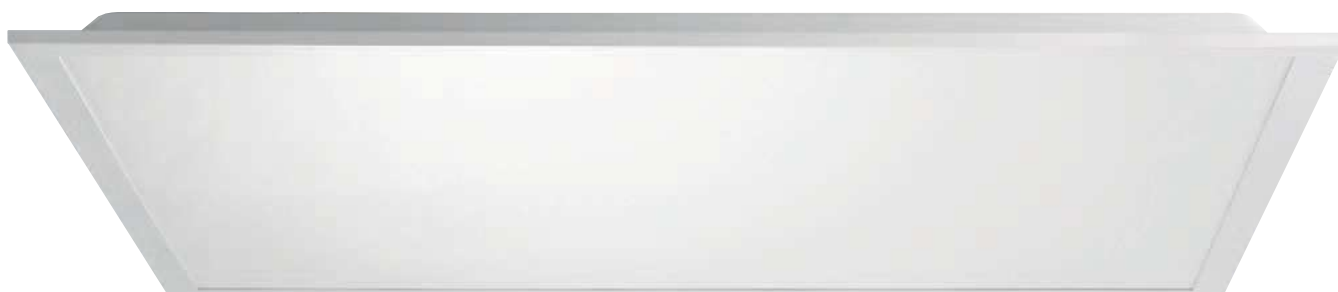

Backlit



 ^{UP TO} 94 lm / W ^{UP TO} UGR < 19 L80 / B20 50.000 h.

Backlit è un apparecchio a led di ultima generazione che si distingue per economicità, efficacia luminosa ed affidabilità nel tempo. Le sorgenti led posizionate sul retro dell'apparecchio emettono luce direttamente verso il basso ottenendo così le migliori prestazioni in condizioni termiche ottimali ed allungando la vita utile dei led il più possibile. Backlit si utilizza in appoggio all'interno di controsoffitti modulari oppure in abbinamento con le soluzioni Modular System per l'installazione a plafone o a sospensione. Backlit è disponibile anche nelle versioni UGR<19.

Backlit is a latest generation LED fixture that stands out for its economy, luminous efficacy and reliability over time. The LED sources located on the back of the appliance emit light directly downwards to obtain the best performance in optimal operating conditions, making sources lifetime as longer as possible. Backlit can be installed as a recessed lighting panel for modular false ceilings or as pendant or ceiling mounted if matched with Modular System's boxes solutions.

- Dimensioni in gamma 60x60 / 30x120 / 60x120 cm.
- Installabile in appoggio in controsoffitti modulari; a incasso trimmed o trimless, a sospensione, a plafone con appositi accessori (non inclusi)
- Alimentazione 220÷240 V / 50÷60 Hz - Classe "II"
- Accensione On / Off – Dimmerabile DALI / PUSH / 1...10 V
- Versioni con controllo digitale "Casambi" o "Pan Digital System (solo per modello UGR)
- Kit Emergenza 1h. e 3h. accessorio (non incluso)
- Alimentatore "no flickering" incluso
- Colore bianco
- IP20 / IK03
- led SMD 3000 K e 4000 K con resa cromatica CRI > 80
- Lenti ottiche tipo "One to Led"
- No UV, No IR
- Emissioni luminose da 3070 a 5500 lumen
- Efficacia luminosa fino a 94 lm/W
- Efficienza energetica A
- Lifetime L80 / B20 – 50.000 h.
- Ottiche 120° e 90° UGR<19
- Temperatura ambiente di esercizio da 0°C a +45°C
- Certificazione CE, RoHS
- 3 anni di garanzia

- *Dimensions 60x60 / 30x120 / 60x120 cm.*
- *False ceiling rest mounting; recessed trimmed or trimless pendant, ceiling or wall mounting thanks to clips as accessories (not included)*
- *Feeding 220÷240 V / 50÷60 Hz – Class "II"*
- *Driver "no flickering" included*
- *Switching On / Off – Dimmable DALI / PUSH / 1...10 V*
- *Digital Control Versions "Casambi" or "Pan Digital System" (only for model UGR)*
- *Emergency Kit 1h. or 3h. as accessory (not included)*
- *Frame color matt white*
- *IP20 / IK03*
- *Led SMD 3000 K or 4000 K; CRI > 80*
- *No UV, No IR*
- *Light output from 3070 lm up to 5500 lm*
- *Optic lenses "One to Led"*
- *Efficacy up to 94 lm/W*
- *Energy Label A*
- *Lifetime L80 / B20 – 50.000 h.*
- *Optics 120° and 90° UGR<19*
- *Operation 0°C a +45°C*
- *Declaration CE, RoHS*
- *Warranty 3 years*

Backlit



90 lm / W

L80 / B20 50.000h.



3 YEARS WARRANTY

Le sorgenti led, posizionate sul fondo del pannello ed abbinata a lenti ottiche di tipo "one to led", emettono la totalità del flusso luminoso nella direzione utile e operano nelle migliori condizioni termiche possibili, ottimizzando il rendimento luminoso e preservando la vita utile del led nel tempo.

(Light Output Maintenance L80/B20 50.000h).

The LED sources, positioned on the bottom of the panel and combined with "one to led" optical lenses, emit the totality of luminous flux in the right direction and operate in the best possible thermal conditions, optimizing luminous performance and preserving the life of the LED over time.

(Light Output Maintenance L80 / B20 50.000h).

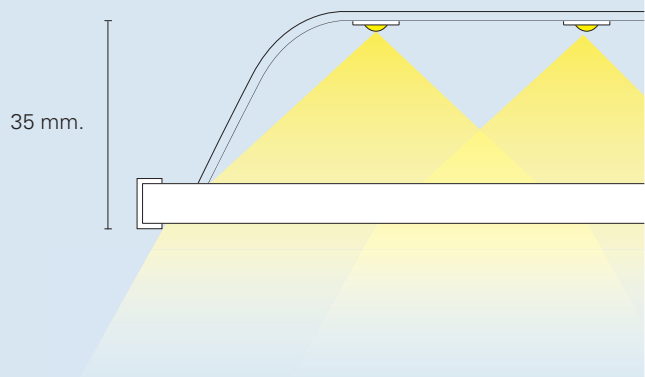

Dimensioni / Dimensions

60x60

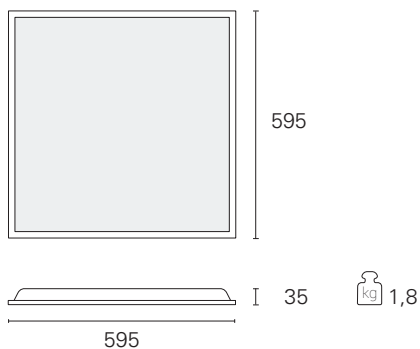

Ottiche / Optics

60x60 120° 4000 K

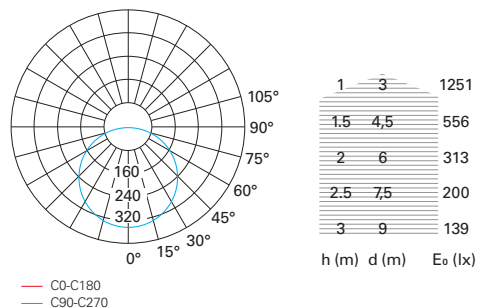

BACKLIT

CRI 80

dimensioni size	versione version	potenza power	codice code	CCT CCT	flusso apparecchio light output	UGR UGR	ottica optic	colore colour
60x60	On / Off	40 W	BAC56040	3000 K	3315 lm	≤ 22	120°	bianco / white
	220 ÷ 240 V		BAC56041	4000 K	3600 lm	≤ 22	120°	bianco / white

vedi accessori di installazione PANEL BOX a pg. 44.
see installing accessories PANEL BOX to pg 44.



Accessori / Dimensions

vedi modalità di installazione a pg. 38.
see mounting operation to pg 38.

Kit Trimmed Recessed

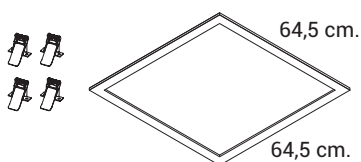

INC1283

Telaio bianco per installazione ad incasso completo di clips.

White frame for recessed panel installation with clips.

Kit Trimless Recessed

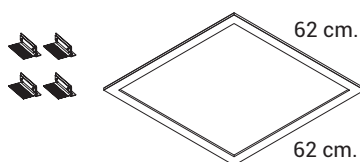

INC1290

Telaio bianco per incasso a filo in cartongesso con cornice a scomparsa completo di staffe.

White frame for trimless mounting on plasterboard with brackets and retractable frames.